

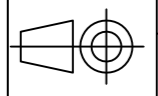

CAD-System:		Tolerance		Scale 1:1		Weight	
						Name and No. of Typ LM_ceiling_details	
08			Date	Name	Title		
07			Draw 22.06.2010	jhe	LM_ceiling_details		
06			Checked XXXXXX	XXXXX	corner profile		
05			Stand XXXXXX	XXXXXX			
04							
03							
02							
01							
Rev	Revision	Date	Name			Drawing No. 1312_Decken	
				Repl. for		Repl. by	



CAD-System:			Tolerance			Scale 1:2	Weight	
						Name and No. of Typ		
08			Date	Name	Title LM ceiling accessories profiles			
07			Draw	22.06.2010				jhe
06			Checked	XX.XX.XX				XXXXXX
05			Stand	XX.XX.XX				XXXXXX
04						Drawing No.		
03								
02								
01						Repl. for		
Rev.No	Revision	Date	Name				Repl. by	

1 2 3 4

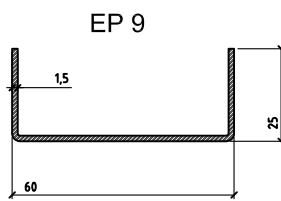
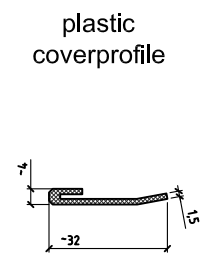
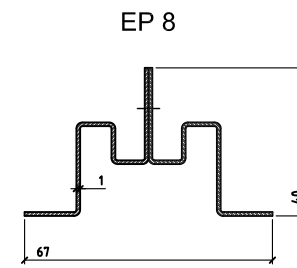
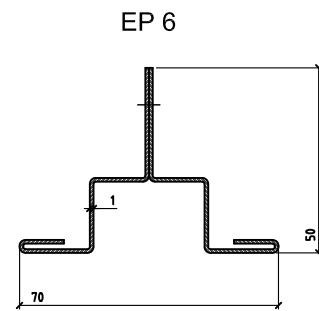
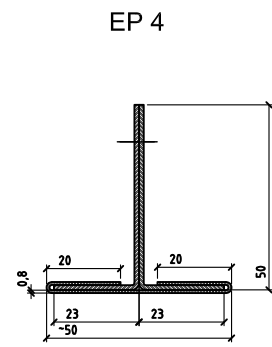
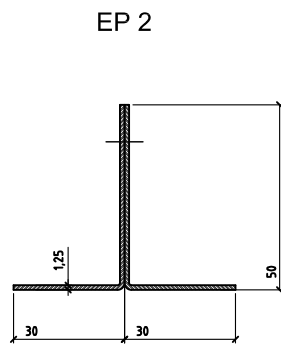
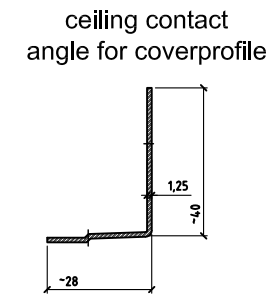
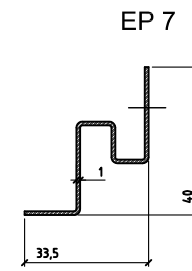
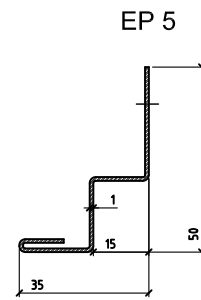
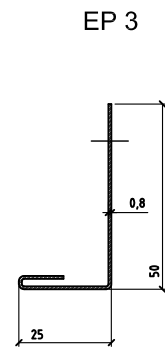
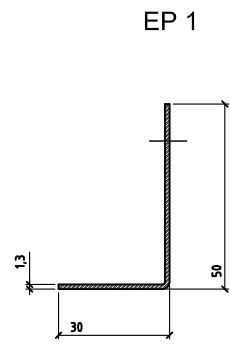
A

Support profile alternative A

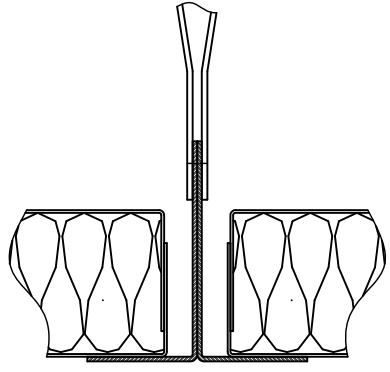

Support profile alternative B

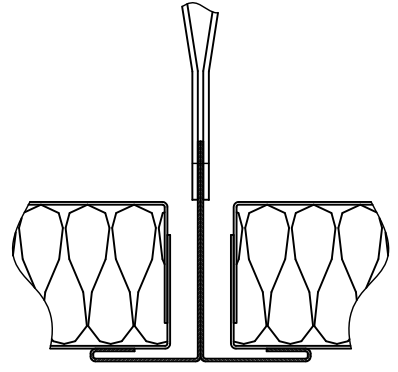

B

C

Support profile alternative C

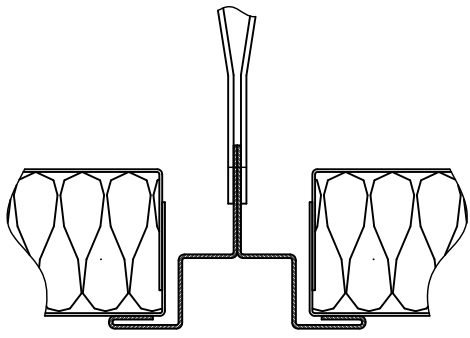

Support profile alternative D for LM40 ceiling sytem only

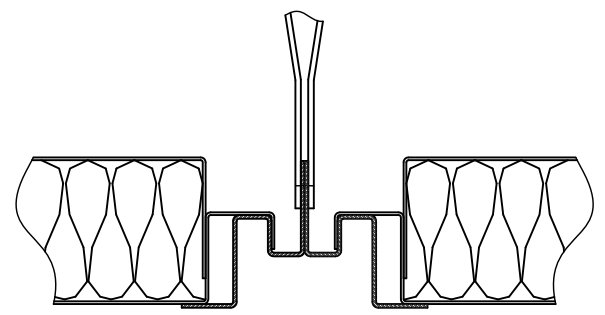

D

E

CAD-System:			Tolerance				Scale 1:2	Weight
							Name and No. of Typ	
08				Date	Name	Title LM ceiling detail support profile		
07			Draw	07.06.2010	jhe			
06			Checked	XX.XX.XX	XXXXXX			
05			Stand	XX.XX.XX	XXXXXX			
04								
03						Drawing No.		
02								
01								
Rev.No.	Revision	Date	Name	LETHE interior outfitting insulation			Repl. for	Repl. by