

⊗ : Type designation
 ▼ : Decor side
 SW: Standard modular width

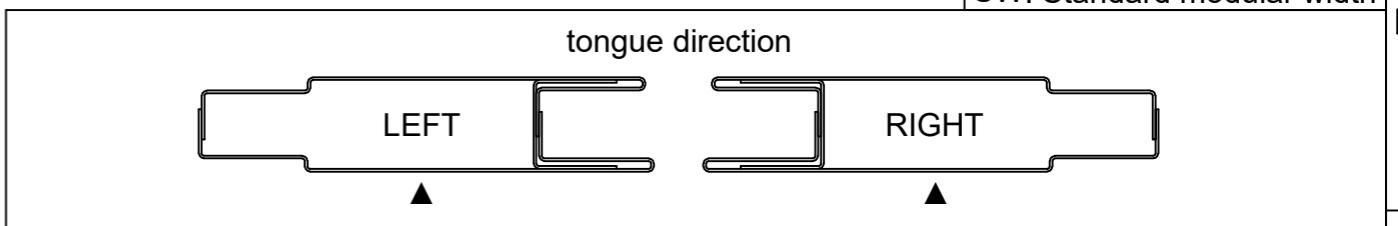

System		material		core / approval			length [mm]	width [mm]	thickness [mm]
Wall	Ceiling	front	back	wool	foam	comb	up to 3000	up to 535	25
W 1	C 3	St 0,75	St 0,75	B 15	without	without			
W 2		St 0,75	St 0,75	B 0	n.a.	n.a.			
W 3		Al 0,8	Al 0,8	B 15	without	without			
W 4	C 2	St 0,75	Al 0,8	B 15	without	without			

CAD-System:		Tolerance		Scale 1:2		Weight	
						Name and No. of Typ	
				LM_System_Panel		Title	
				LM_25_System_Panel		Title	
						Drawing No.	
08				Date		Name	
07				Draw 28.05.2010		jhe	
06				Checked XX.XX.XX		XX.XX.XX	
05				Stand XX.XX.XX		XXXXXX	
04							
03							
02							
01		Ceiling "C1" removed		04.05.2020		IH	
Rev.No.	Revision	Date	Name			Repl. for	
						Repl. by	

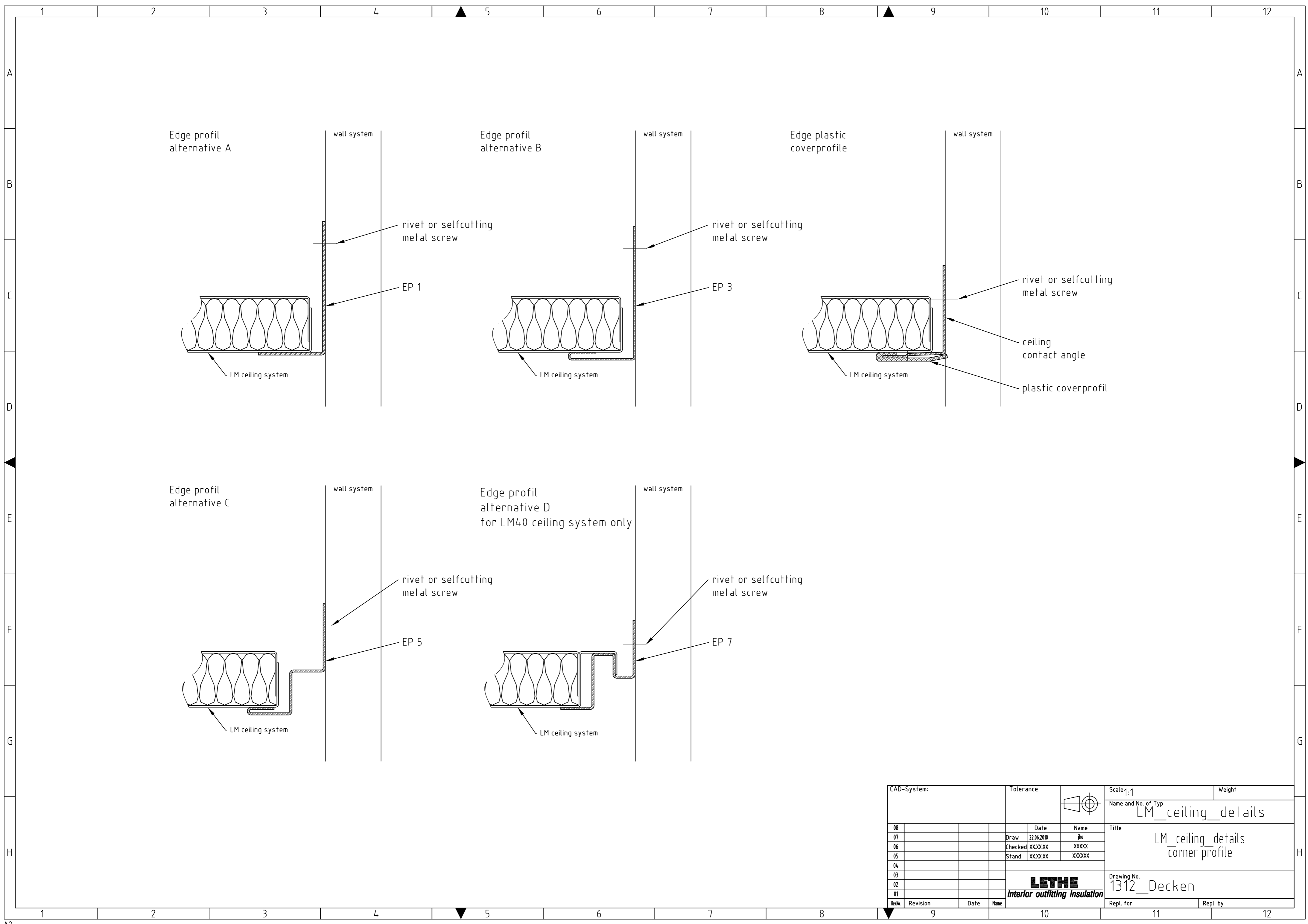

Edge profil alternative A

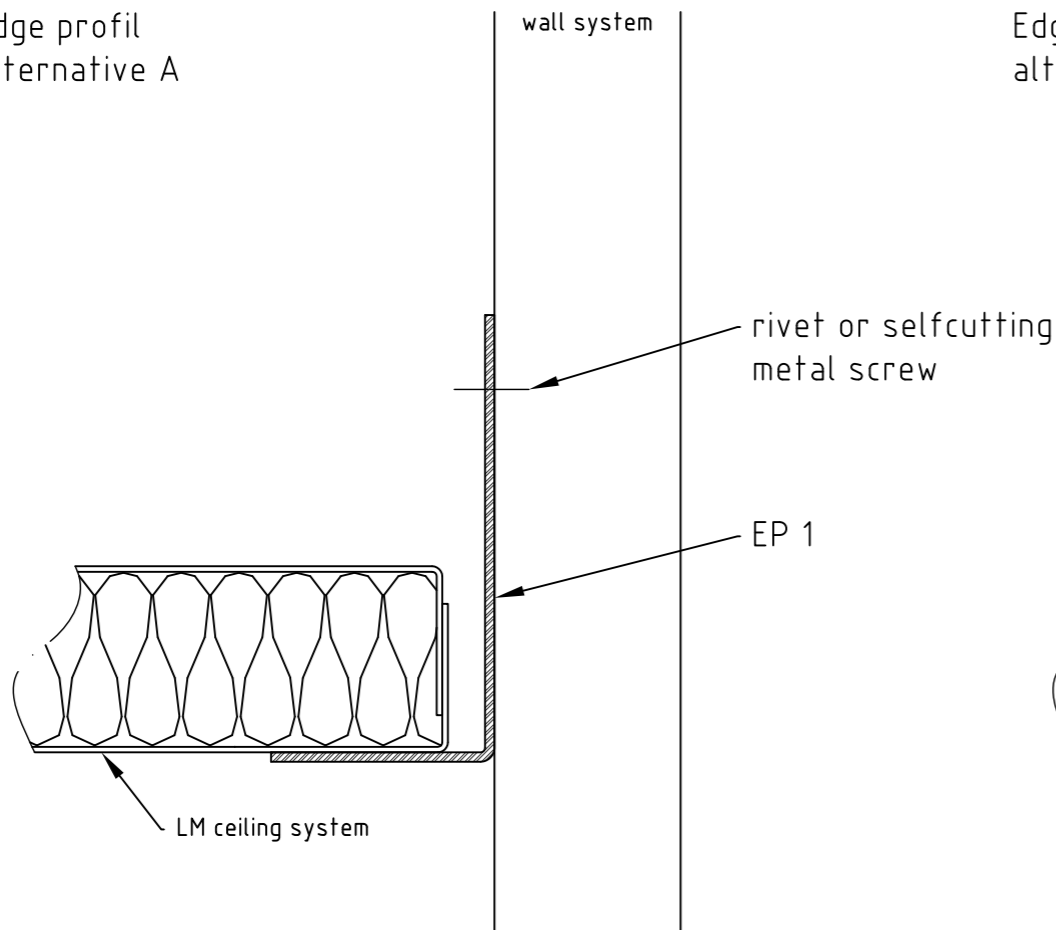

Edge profil alternative B

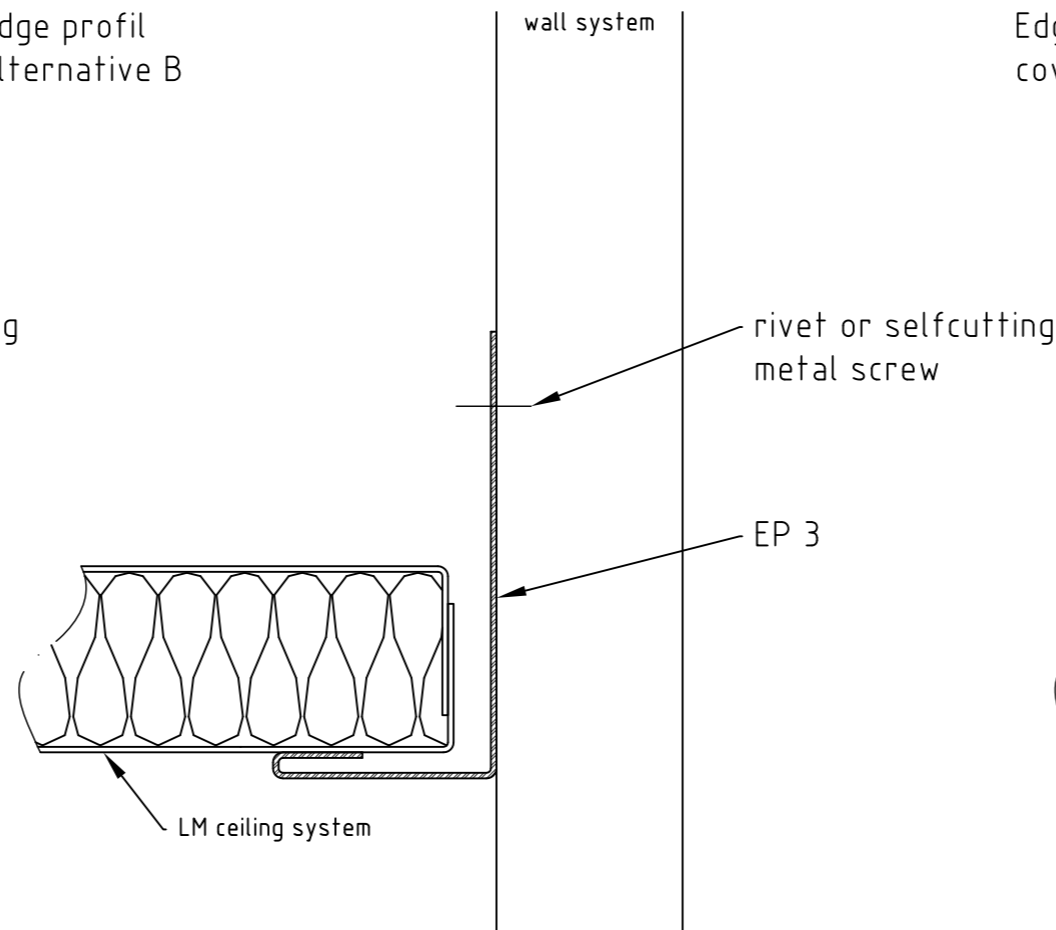

Edge plastic coverprofile

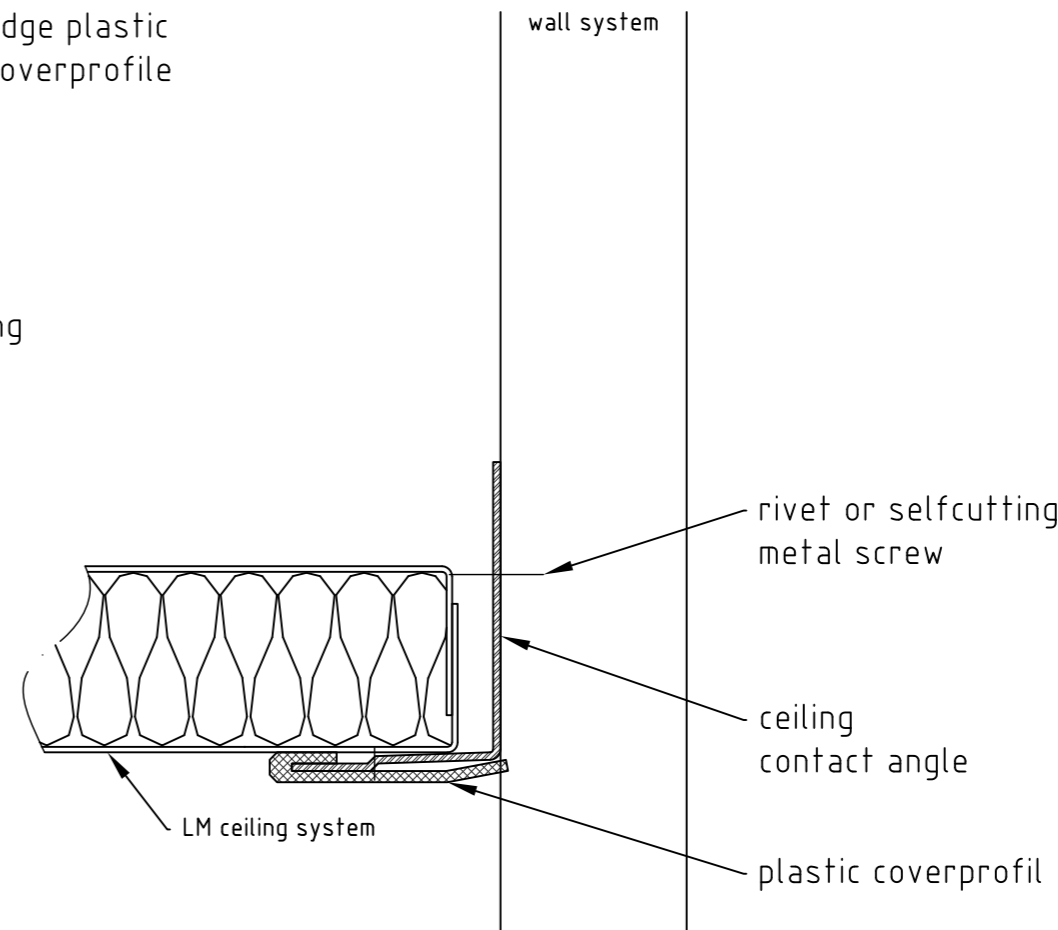

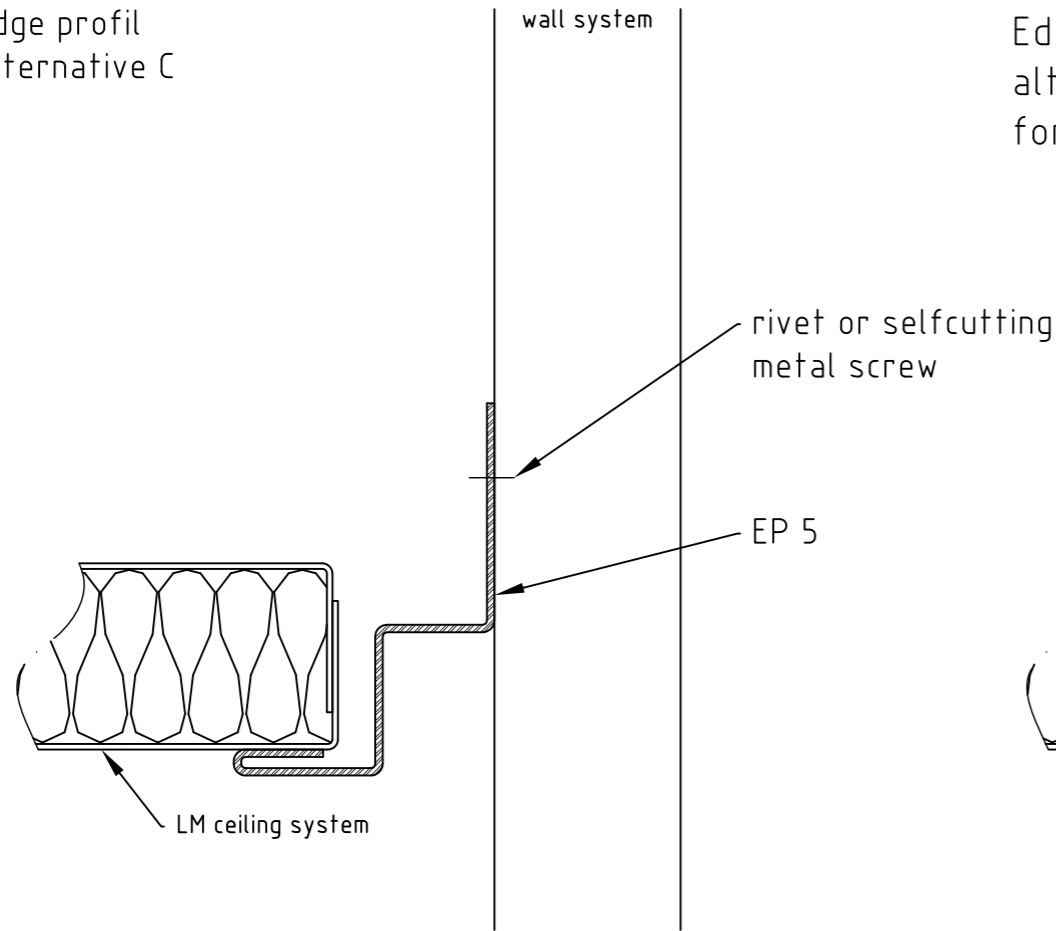

Edge profil alternative C

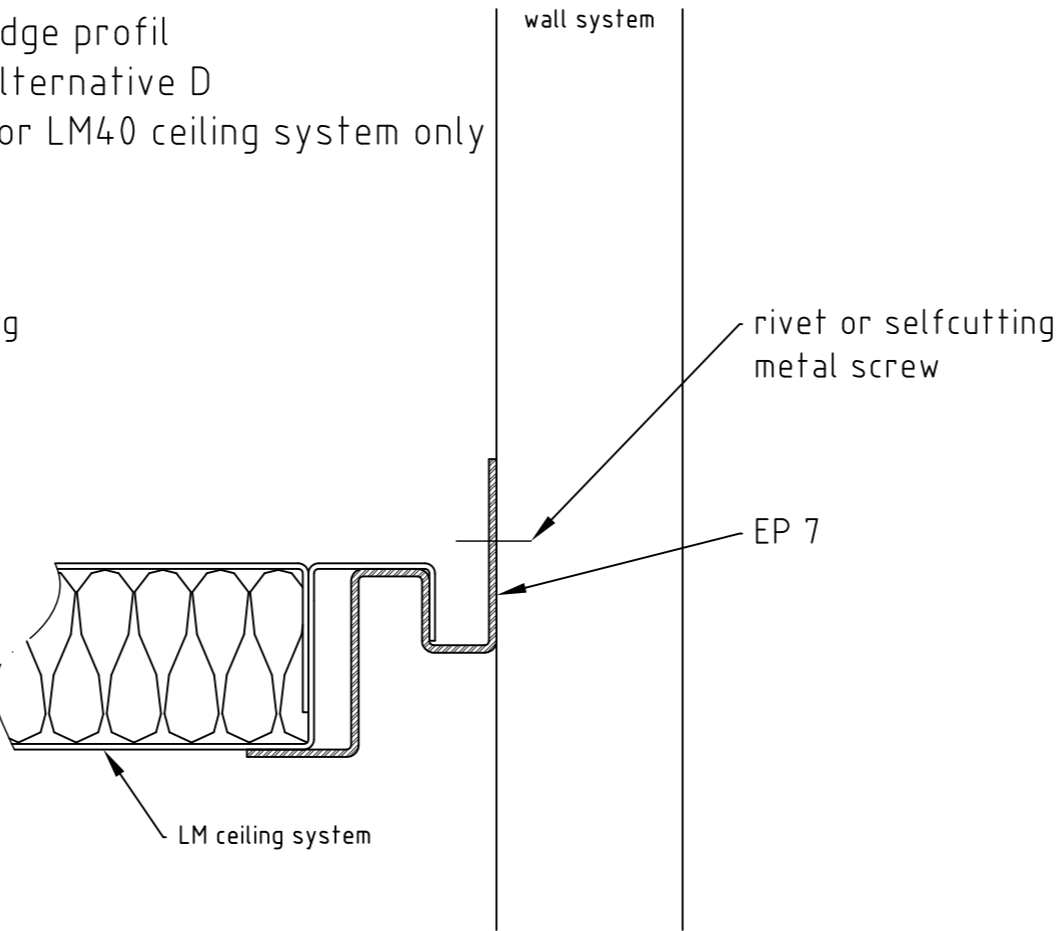

Edge profil alternative D for LM40 ceiling system only

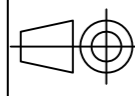

CAD-System:		Tolerance		Scale 1:1		Weight	
						Name and No. of Typ LM_ceiling_details	
08				Date	Name	Title LM_ceiling_details corner profile	
07				Draw	22.06.2010	jhe	
06				Checked	XX.XX.XX	XXXXX	
05				Stand	XX.XX.XX	XXXXXX	
04							
03							
02							
01							
		Drawing No. 1312_Decken		Repl. for		Repl. by	
Rev.	Revision	Date	Name				

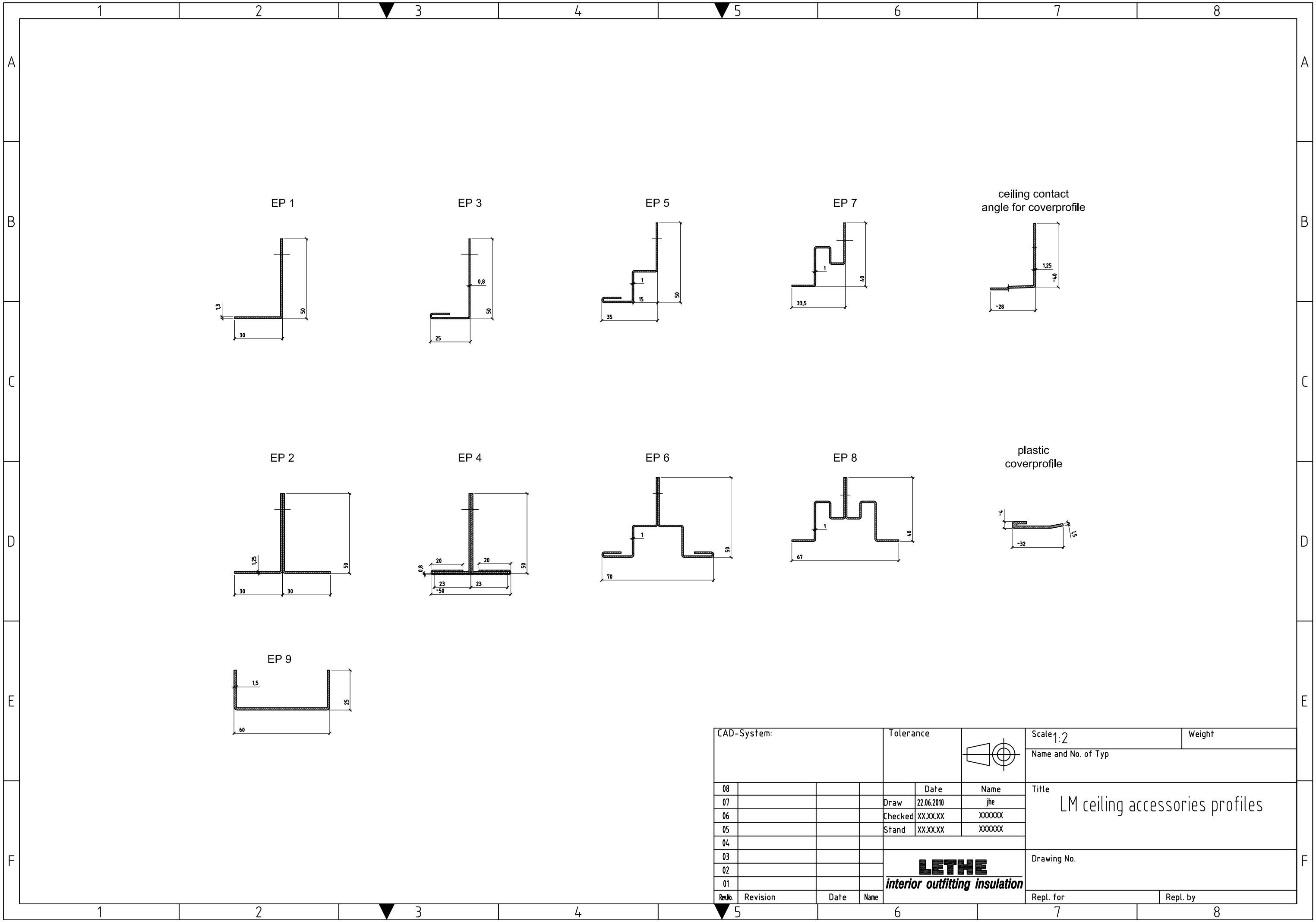

CAD-System:		Tolerance		Scale 1:2		Weight		
				Name and No. of Typ				
08				Date	Name	Title LM ceiling accessories profiles		
07				Draw	22.06.2010			jhe
06				Checked	XX.XX.XX			XXXXXX
05				Stand	XX.XX.XX			XXXXXX
04				LETHE interior outfitting insulation		Drawing No.		
03								
02								
01						Repl. for		
Rev.No	Revision	Date	Name			Repl. by		

1 2 3 4

A

Support profile alternative A

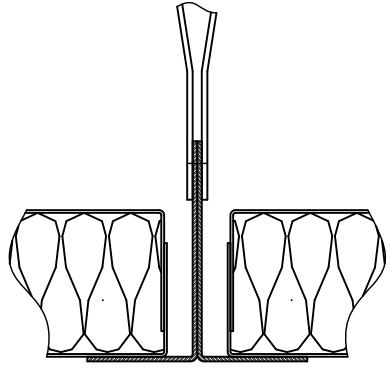

Support profile alternative B

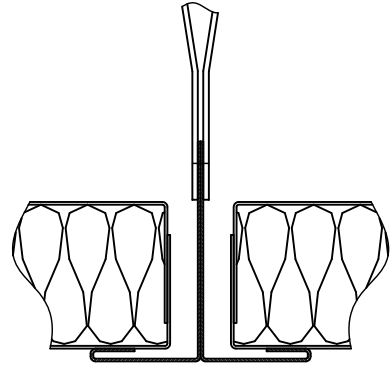

B

C

Support profile alternative C

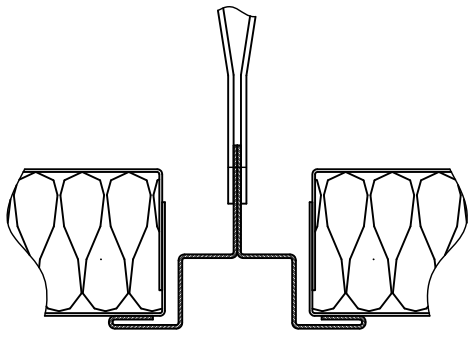

Support profile alternative D for LM40 ceiling sytem only

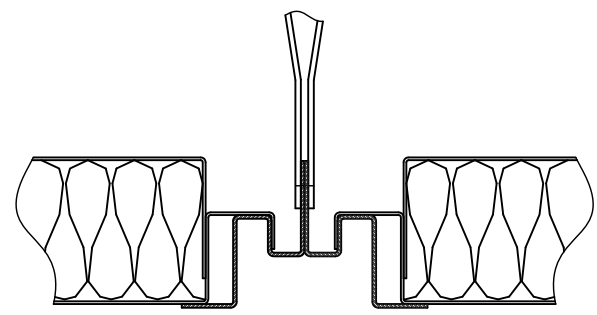

D

E

CAD-System:			Tolerance				Scale 1:2	Weight
							Name and No. of Typ	
08				Date	Name	Title LM ceiling detail support profile		
07			Draw	07.06.2010	jhe			
06			Checked	XX.XX.XX	XXXXXX			
05			Stand	XX.XX.XX	XXXXXX			
04								
03						Drawing No.		
02								
01								
Rev.No.	Revision	Date	Name	LETHE interior outfitting insulation			Repl. for	Repl. by